



 **LG Hausys**

[www.himacs.eu](http://www.himacs.eu)

# HI-MACS<sup>®</sup>

HI-MACS<sup>®</sup> façades.  
Because Quality Wins.



Natural Acrylic Stone<sup>™</sup>

HanselMerkur - Hamburg, Germany | Design: Queisler + Partner Architekten GmbH, Wasfy Taha, Flynn Mägel | Fabrication: Likoo / Betriebsgesellschaft GmbH | Photo credit: © Dominik Reiphae Fotograf

# Off outside.

If you have worked with HI-MACS® materials before, you will know the effect: your own ideas and the creative material inspire each other producing even more outstanding ideas. HI-MACS® can give shape and form to virtually any of your design ideas.

And now, you can use HI-MACS® outside. With its limitless possibilities and exceptional quality, its the perfect façade material.

Highly functional and exceedingly beautiful façades have been designed since HI-MACS® S728 Alpine White, combined with KEIL inserts and a BWM structure, successfully passed all relevant ETA.



Design: PAD Architectes for BERI 21 | Fabrication: LCCA | Photo: Mathieu Ducros



Design: Dipl.-Ing. Volker Wiese, Berlin - Kaden Klingbeil Architekten | Fabrication: Kiebitzberg GmbH & Co.KG – Kloepfer Surfaces | Photo: Dirk Wilhelmy

Design: by preiswerk marek architekten | Engineering: 5D Engineering | Photos: Uwe Roder



Train passengers arriving in Schwäbisch Gmünd are greeted by the bright underpass: the entire wall was designed in Alpine White HI-MACS®. Made of the Natural Acrylic Stone™ the curved backlit panels covering the walls of the tunnel in Schwäbisch Gmünd guide visitors to the exit. The exceptional quality of HI-MACS® means it was the perfect material for this project.





HI-MACS® offers clear advantages, especially when compared with other mineral materials:

#### Outdoor applications

The HI-MACS®-FR-quality has been tailor-made for outdoor applications and its resistance to UV radiation surpasses that of any other solid surface.

#### Fire rating test

The HI-MACS®-FR-quality passed the fire rating test with far better results than any of the other solid surfaces: The achieved SBI test according to EN-13501-1 is the impressive proof of this.

#### HI-MACS® façade colour range

The other 13 colours of the outdoor range, too, achieved good results in terms of fire rating. Their excellent results: B1, which allows application in almost every relevant area.

#### HI-MACS® is ETA certified

Fixed with KEIL inserts and a BWM structure, HI-MACS® façade in S728 – Alpine White successfully passed the ETA (European Technical Agreement) tests.

It is in the outdoor applications in particular where HI-MACS® scores with its outstanding properties:

#### Easy thermoforming

Organic-curved, three-dimensional façade architecture thanks to the thermal moulding capacity of the material.

#### Translucent qualities

Spectacular light and surface effects are achieved by milling and backlighting.

#### Advantageous outdoor properties

The HI-MACS® façade colour range withstands humidity, UV radiation or variations in temperature thanks to homogeneous, non-porous material and other advantageous properties.

#### A durable material

Easy to clean and maintain, the perfect function and visual effect will last for many years (even damage caused by graffiti can be removed without any trace).



The HI-MACS® panels are fixed to a clamp using undercut anchors and are then suspended from an aluminium substructure. Horizontal and vertical joints equalise temperature fluctuations and guarantee the necessary rear ventilation of the wall.



## The house that plays with light.

HI-MACS® has a sensuous way of dealing with light: When used as a facade the material provides great aesthetic properties. The light is absorbed or reflected, depending upon the intensity and angle of incidence, and gives the Sokcho Housing in Alpine White a mystical feel.



At first glance, the silhouette of this house appears to be simple. However it posed a challenge to architects and finishers: the interlocking cubes, some with seamless surfaces, some with distinctive dividing lines, are all made of HI-MACS®.





# When the façade tells a story.

The façade of the Bieblova residence project, built using HI-MACS® Solid Surface, has been designed by P6PA+Architects as a tribute to Konstantin Biebl, a prominent Czech poet from the inter-war period who lends his name to the street in Prague where the building is located.



Precise milling, effective back-lighting, near-invisible installation equipment and the robustness of an inner-city facade: HI-MACS® offers all this.

Design: P6PA+Architects, s.r.o., p6pa.cz, Martin Klejna, Javier Navas Fabregat | Fabrication: Duolift s.r.o., Atlas Group s.r.o., Dřevovýroba Podzimek s.r.o. | Photo: Miguel Alonso





## Formed by a sea breeze.

This ultra-modern villa on the French Riviera conjures images of a super yacht: With its striking railing, different-sized portholes made of HI-MACS® and especially the sinuous wind- and weather-resistant facade made of the same high-tech material, this impressive building perfectly reflects its maritime location above Cannes.

Our HI-MACS® material dominates inside as well as out. The outstanding thermoforming qualities which are vital to architects and designers work inside, while the resistance to wind, weather, UV radiation make HI-MACS® the perfect outdoor material.





## Making a grand entrance.

The roof sculpture appears to float above the entrance. In reality, the striking roof and wall construction was seamlessly assembled from over 100 large-scale HI-MACS® plates. Coupled with its timber and steel substructure, this produces an aesthetic and yet stable masterpiece.



The entrance foyer opens to the outside through the large windows. Inside, the ceiling that lets light flood in coupled with the reception desks, both made of HI-MACS®, provide a link to the exterior façade made of the same material.



# HI-MACS® transforms from day into night.

This impressive gate can be seen at a busy road in the heart of Berlin. The exterior of the gate is entirely clad with HI-MACS® material. The material is carried on all the way to the interior and is produced in a stylish white throughout.

While the robust and effectively staged surface dominates the façade outside, it is the many small fabrication details inside which offer the arguments in favour of HI-MACS®: both the address and a clear pattern of dots create an impressive effect. Thanks to our exclusive Thermalcure technology, HI-MACS® can be effectively machined, and milled.

But the special highlight can only be seen at night: the entire gate is fitted with an LED technology which is invisible during the day. Graphic patterns or letters can be projected on the HI-MACS® surface, turning the straight installation into a dynamic stage for lighting design.



During the day, the lighting technology is invisibly hidden and protected by the robust HI-MACS® surface.



Customers of this office complex are enthusiastic about the animated snowflakes visible on its façade.



Design: neo systems architects | Engineering: 5D Engineering GmbH | Photo: Volker Mai



Photo: Andreas Mikutta

Effectively animated outside, inside a clear design of dots and letters milled out by using the CNC technology.



One of the most important features when using HI-MACS® on a façade is its ability to create round corners.



# Non-standard façade. Unlimited design.

ETA certified, thermoformable, polyvalent, ultraresistant, and non-porous, HI-MACS® new generation acrylic stone has enabled the construction of a non-standard façade that, in all respects, complies with the requirements of the world leader in sailing-boat construction.

In addition to the aesthetic effect with a motif that is inspired by fishing nets, reproducing the Bénéteau logo and recreating a wave, the perforation of the material, which is over 50%, provides the required level of transparency whilst regulating heat from radiation.



Design: PAD Architectes for BERI 21 | Fabrication: LCCA | Photo: Mathieu Ducros





# Shaping the future. In harmony with the environment.

Countless internationally recognized certificates attest that HI-MACS® has a strong focus on ecological aspects. Without exception, all HI-MACS® products are manufactured in accordance with the ISO 14001 environmental standard.



When you approach the beautiful linear building, you simply can't believe that it was the material's ecological and sustainable aspects that first and foremost advocated the use of HI-MACS®. Apart from its sensational aesthetic qualities, it was also its impressive feel that was crucial when it came to making a decision.

Architect and builder Volker Wiese has realised his personal home design dream with a Bauhaus style residence with exterior HI-MACS® cladding that secures privacy from the outside but encloses a delightful garden with-in a multi-façade, two wing

design. For the keen nature lover that Wiese is, using acrylic stone for the exterior wall cladding was an obvious choice as all the materials used in this energy efficient structure are sustainable.



HI-MACS® is adaptable to all styles.

Integrating a new contemporary building in a historic ensemble calls for tried and tested expertise in project management. Accordingly, the architect Florian Köhler imitates the plan of the façades constructed with plaster mouldings on the old buildings in the Ottensen district in Hamburg, and applies it to his new project using HI-MACS® panels.



To echo the smooth, dazzling white surfaces of the historical buildings, the architects chose brilliant white light reflecting panels made of "Alpine White" HI-MACS®, giving the dynamic shapes of the surface a certain depth effect.



Design: Kohler Architekten | Fabrication: Peter Knapp Dach und Fassadentechnik GmbH, Abalit Elementos Moldeados, Peter Grube | Photo: Nikolaus Herrmann



## Maximum versatility for creative design.

This modern building houses the oil company NAM (Nederlandse Aardolie Maatschappij) in Assen, Netherlands. The reception area is almost entirely built in HI-MACS®, starting with the exterior façade decorated with a backlit sign representing the company's logo.



The architectural firm Kwint Architecten designed a reception room which receives visitors in a continuous flow between the outside and the inside, using a HI-MACS® wall which links the two areas and eventually leads to the reception desk. The interior partition is finished and backlit to create a bas-relief which echoes the identify of the brand. Its a great result, when architect and client join together to make such a quality building.

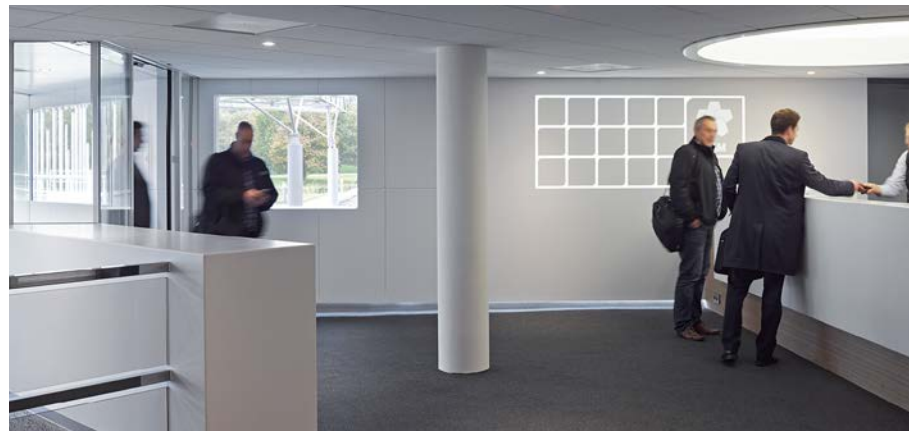

Design: Kwint architecten | Fabrication: Bouwborg -Harryvan b.v. | Photo: Gerard van Beck.



The use of the HI-MACS® material for the window frames, the walls and the furniture helps to create a homogeneous and refined unit which has enabled a new area to be integrated into existing architecture without creating conflict.



## Convincing inside.

### Inside public buildings.

The requirements for public spaces are very demanding. HI-MACS® regularly undergoes all the necessary material tests and has all the requisite certificates to meet these exacting quality requirements. The use of HI-MACS®, the Natural Acrylic Stone™ by LG Hausys, in this swimming pool in the heart of Paris's 19th district has achieved a superb finish.

This innovative project proves once again the diversity and exceptional quality of this solid surface material: the optimum dimensional tolerance of HI-MACS® was extremely important for achieving a perfectly worked result in this challenging swimming pool project with its large flush-mounted wall panels.



Design: Yonseux Architectes | Fabrication: ASKA Interior | Photo: Alexandra Mocanu

Design: SchröderArchitekten | Fabrication: Kiebitzberg Möbelwerkstätten – Klöpfer Surfaces | Photo: Dipl. Ing. Arch. F. Aussleker



### All of a sudden a building has haptic qualities.

## Convincing outside.

These white elements create a uniform impression: all window framings and some wall elements are made from HI-MACS®, increasing the value of the building considerably. Especially the bottom section of the façade which is within reach of passers-by: wonderful if spectators “look with their hands” being able to feel the perfect touch of the material.





With HI-MACS Exteria<sup>®</sup>, it's now even more fun to be on the move outside.

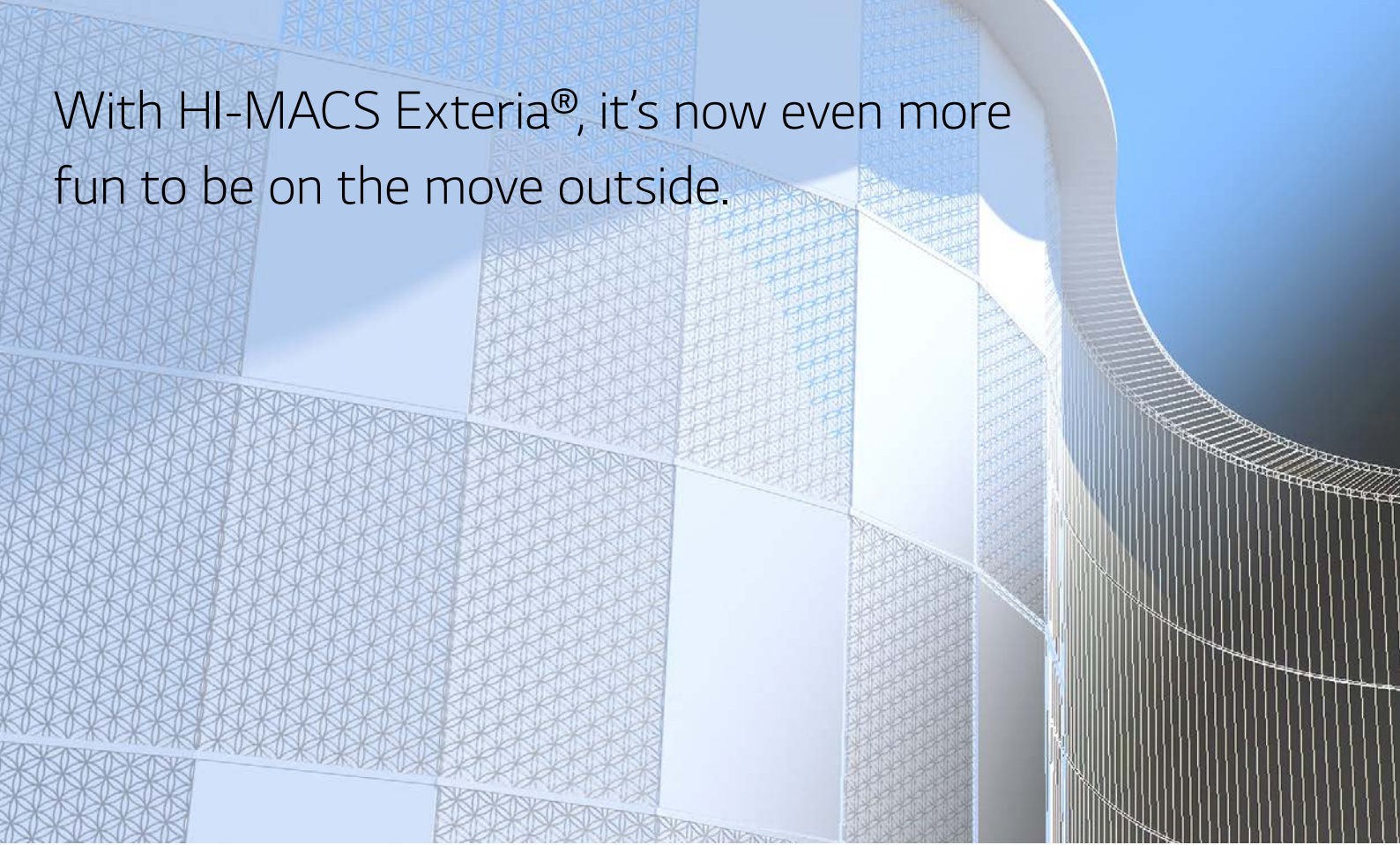

Alpine White  
S728



Alpine White  
S828

- S728 (Alpine White) is the FR formulation, which for many years, has offered increased fire resistance – certified by the ETA.
- S828 (Alpine White) is the new exterior formulation offering better UV resistance, which is particularly important when the façade is exposed to high levels of sunlight.
- All colours labelled with a sun symbol can also be used outdoors.

For years, spectacular façades have been made from HI-MACS<sup>®</sup> all over the world. In doing so, the advantages are often skilfully crafted: Relief milling with writing, samples with company logos, combined with spectacular light effects and curvy designs. And every good design inspires the next big thing. Together, we can now take the next steps. With HI-MACS Exteria<sup>®</sup>, LG Hausys is expanding exterior possibilities.



Design: Woo-jin, LIM AEV Architectures | Photo: AEV Architectures



# Choose the outdoor expert.

In Europe, for good reasons, there are strict regulations regarding material behaviour, especially the fire performance. This applies to many areas within a building, as well as to its façade, rendering a lot of materials unsuitable for use in safety relevant areas.

The HI-MACS® Outdoor Range offers a choice of attractive shades and, above all, maximum safety for the planner, the fabricator and the builder – last but not least for the occupants of the building.

HI-MACS façade colour range achieved for example the B-s1-d0 classification of SBI (Single Burning Item) according to the norm EN ISO 13501 as well as the German B1 classification according to the norm DIN 4102-1; and the M1 classification according to the French norm NF P92-501.

## Warranty

HI-MACS® offers a 10-year warranty on the UV resistance of the exterior colours. The loss of shine is less than 40% with matt finishes. A 10-year warranty that the colour does not leach and 20-year warranty that the material does not flake off, swell or become delaminated is also offered. The warranty period starts from the installation date and only applies to the sheet material. Adhesives are excluded from the warranty. The warranty conditions are based on practical experience and tests are continuously performed in independent laboratories. For more information visit [himacs.eu](http://himacs.eu).

## Great UV resistance.

This is where the quality of the HI-MACS® material comes into its own. Some colours are rated with the UV classification Delta E2, E5 and other colours are rated Delta E15 during 10 years.

# HI-MACS Exteria®

## HI-MACS®

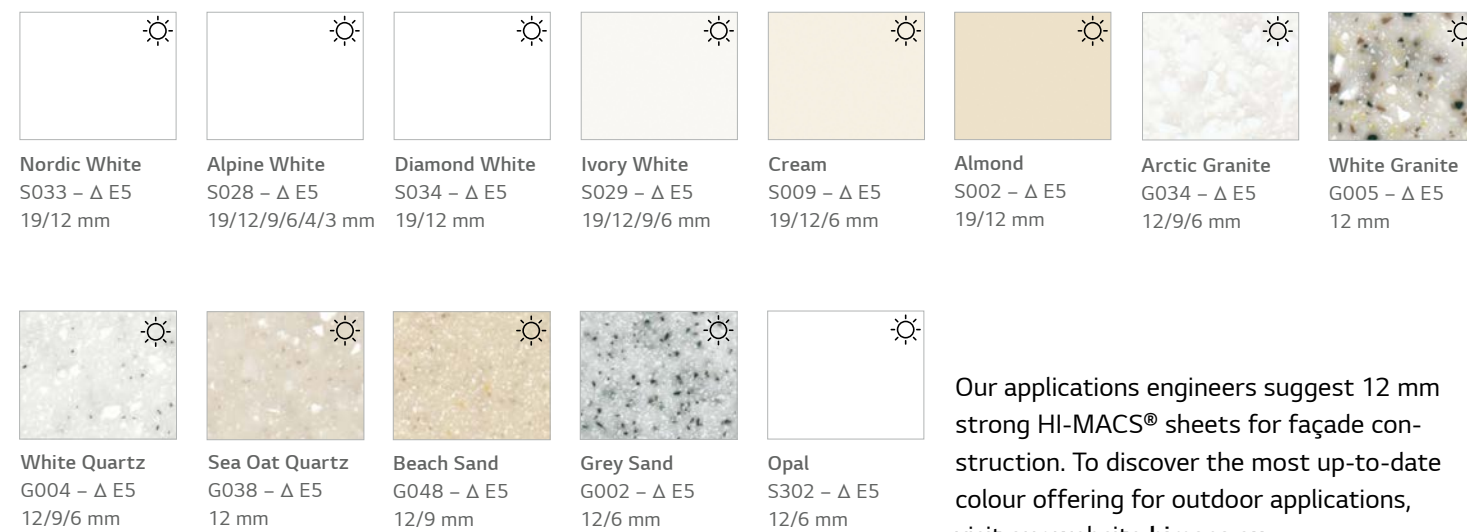

Our applications engineers suggest 12 mm strong HI-MACS® sheets for façade construction. To discover the most up-to-date colour offering for outdoor applications, visit our website [himacs.eu](http://himacs.eu).

## HI-MACS® Alpine White for special requirements

### HI-MACS® – Improved UV resistance



Alpine White  
S828 - Δ E2  
12 mm

All requirements of the categories of Avis Technique and CSTB are fulfilled. In addition we achieved FR in M1 France.

### HI-MACS® FR – Minimal flammability



Alpine White  
S728 - Δ E5  
12 mm

The individual material FR quality resulted in fire protection classification "B-s1-d0" according to EN 13501 (Single Burning Item test (SBI test))\*.

Fixed in place with KEIL anchors and a BWM construction, the HI-MACS® façade in FR S728 CE MED Alpine White successfully passed the ETA tests (European Technical Agreement).



Great Quality Material means great resistance to the outdoors.

## Technical Properties

SPECIFICATION		RESULT	UNIT	TEST METHODS
Flexural E-modulus	Ef	8900	MPa	DIN EN ISO 178
Flexural strength	$\sigma_{fm}$	76,9	MPa	DIN EN ISO 178
Breaking elongation	$\epsilon_{fm}$	1,01	%	DIN EN ISO 178
Electrostatic Conductivity		$> 1 \times 10^{12}$	$\Omega$	EN61340-5-1 DIN IEC 61340-4-1
Diffusion resistance coefficient	$\mu$	1807		DIN EN ISO 12572
Density		1,71	g/cm <sup>3</sup>	ISO 1183
Heat conductance	$\lambda_{10tr}$	0,636	W/mK	DIN EN 12664
Resistance to thermal expansion	R	0,048	m <sup>2</sup> K/W	DIN EN 12664
Thermal expansion coefficient	$\alpha$	0,048	mm/mK	prEN 14581
Linear expansion coefficient		max. $48 \times 10^{-6}$	m/°C	
Tensile resistance	$\sigma_{fm}$	32,7	MPa	DIN EN 527
Water absorption		< 0,1	%	DIN EN 438 – part 12
SBI fire performance		B - s1 - d0		DIN 13501

\*applicable to HI-MACS® FR S728 Alpine White, tested with subconstruction and insulation

## Fire performance

PRODUCT CONCERNED	TEST METHOD	RESULTS
HI-MACS® FR - 12mm	DIN EN 13501-1, SBI	B-s1-d0
HI-MACS® FR - 12mm	NF P92-501:1995	M1
HI-MACS® FR - 12mm	DIN 4102-1 EN 13501-1	B1 B-s1-d0

## HI-MACS Exteria® Certificates



HI-MACS® by LG Hausys has obtained the French QB certification and CSTB ATec "Avis Technique" for facade applications in S828 Alpine White.  
(Avis Technique 2.2/18-1795\_V1).

Fixed with KEIL inserts and a BWM structure, HI-MACS® façade in S728 – Alpine White successfully passed the ETA tests (European Technical Agreement).



# The appropriate technology: HI-MACS® as a ventilated rainscreen façade.

## A cross-section of the rear-ventilated façade.

If you would like to benefit from the wonderful design possibilities and functional advantages offered by HI-MACS® and use it as façade material, we suggest planning a ventilated rainscreen façade. This very common system separates the thermal-insulation and weather-protection functions.

Here HI-MACS® benefits from its special mix of significant properties which render the material virtually predestined for outdoor application. The certain dimensional tolerance of HI-MACS® is an attractive feature for the material.

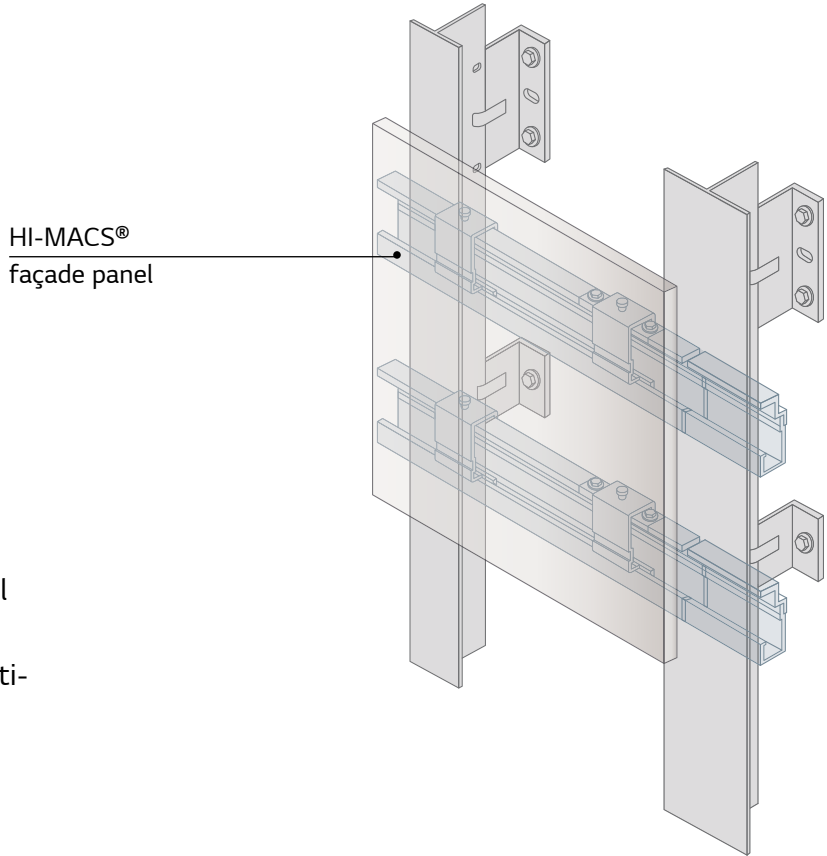

**The subconstruction on the wall.**  
Through the way panels are anchored to the wall professionally, the cross-section here opposite demonstrates the construction method of a ventilated rainscreen.

## Simple flashing details.

HI-MACS® and the recommended subconstruction also allow the installation of roof and wall flashings or windowsills – easily and without any problems, just like the entire façade.

Attic flashing  
(upper flashing)

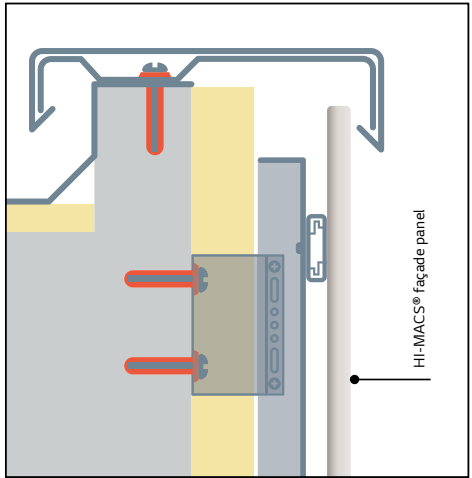

Windowsill

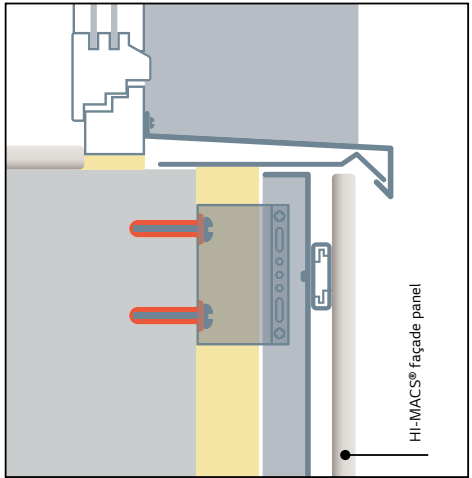

Base flashing  
(lower flashing)

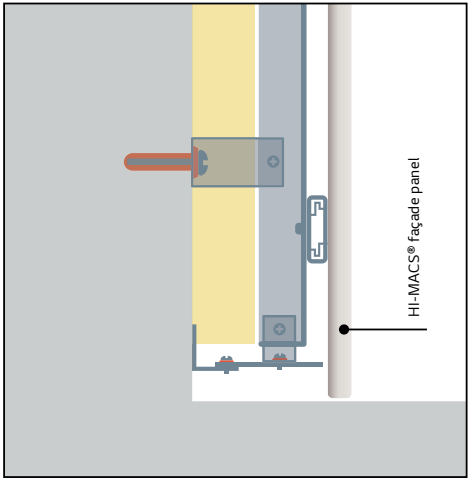



Perfect protection against all external influences.  
Thanks to the ventilated façade – and HI-MACS®.

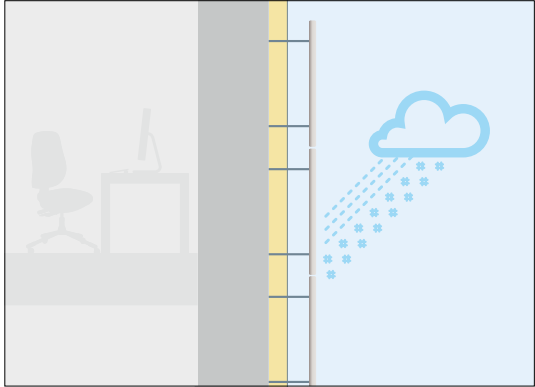

**Perfect moisture resistance**  
HI-MACS® is highly resistant to moisture like rain, snow or condensation, thus providing excellent protection for the insulation layer behind the façade. Furthermore, any moisture is perfectly removed via a gap between the façade panel and the insulation material.

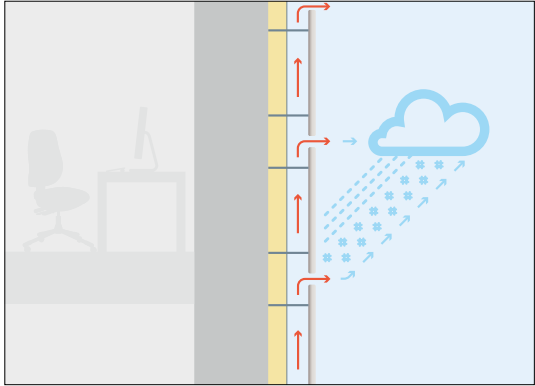

**Perfect air circulation**  
In connection with the ventilated rainscreen technology, HI-MACS® ensures air circulation irrespective of low or high temperatures. This method removes condensation moisture and prevents damage to the insulation layer.

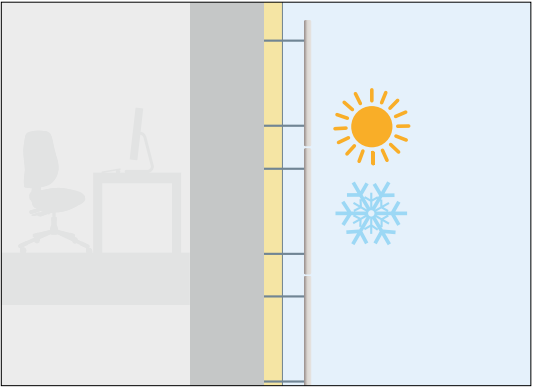

**Perfect insulation properties**  
HI-MACS® withstands cold and heat equally. These insulation properties result in significant energy savings.

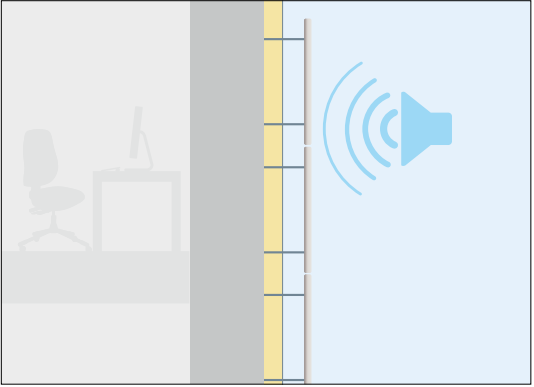

**Perfect noise insulation**  
HI-MACS® façade materials provide optimal noise insulation thus reducing the noise level significantly.

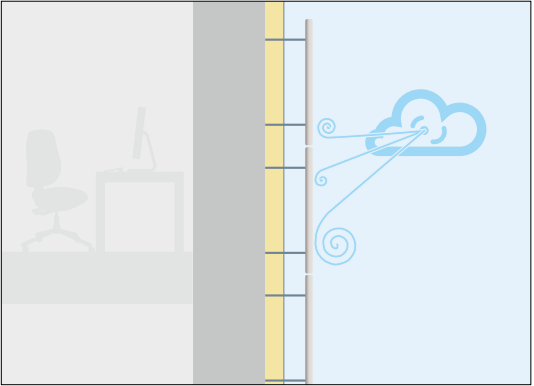

**Perfect resistance to wind pressure**  
HI-MACS® façade materials attest bending strength above average thus offering excellent resistance to wind pressure.



## The optimal method of mounting HI-MACS® on walls.

Adjustable aluminium subconstructions are used for the professional mounting of HI-MACS® façade elements. LG Hausys suggests using proven highquality products such as those offered by BWM installation system.

These elements are used to anchor HI-MACS® slabs on walls leaving a 20 mm gap between the slabs and the insulation material: a perfect space for the vital air circulation. The insulation layer itself is well kept in place between the aluminium sections and the wall.

Depending on the state of the building, the subconstruction is aligned to the individual requirements determined by the architect.

HI-MACS® panels are mounted – invisibly from the outside – to the aluminium substructure. We recommend using an invisible undercut anchor which is offered by KEIL attachment technology.



KEIL undercut anchor

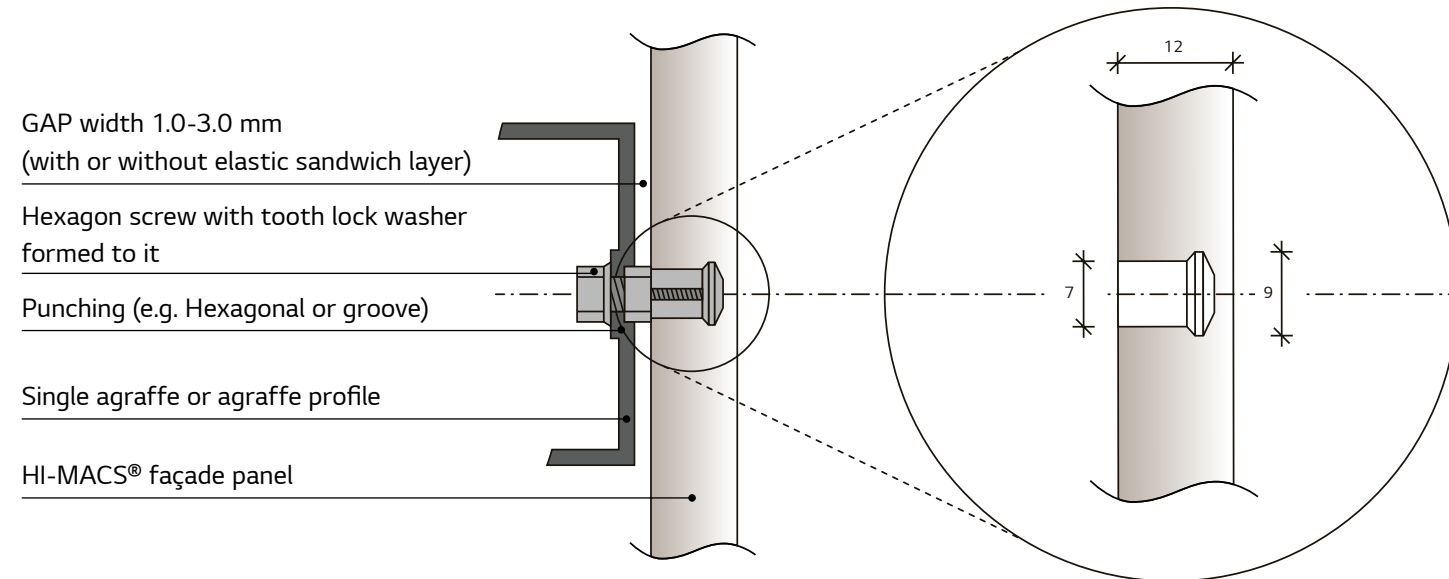

## How to join the panels.

There are different ways of joining two HI-MACS® panels within the ventilated rainscreen. The methods shown here allow for expansion joints of at least 8 to 10 mm.

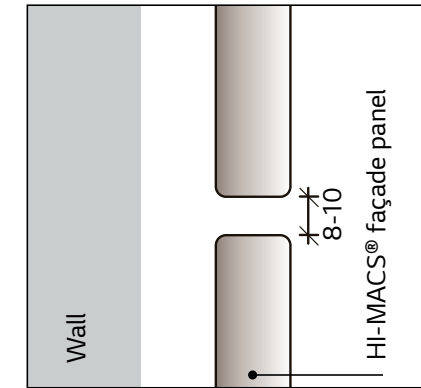

Open joint  
without sealing on the reverse side

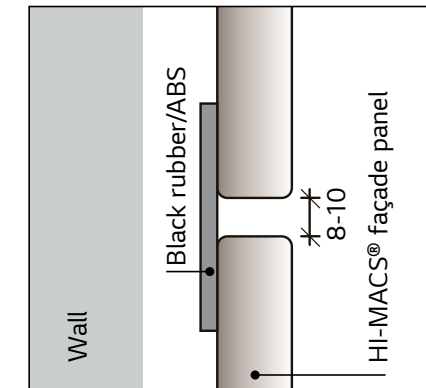

Open joint  
with sealing on the reverse side  
(rubber or ABS plastic)

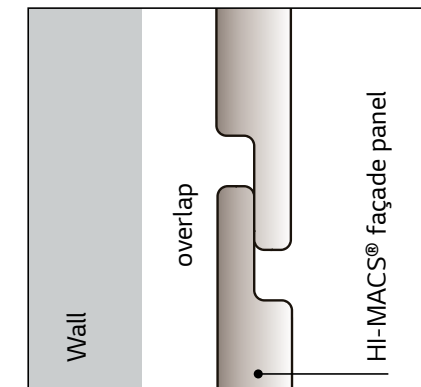

Overlapping panels

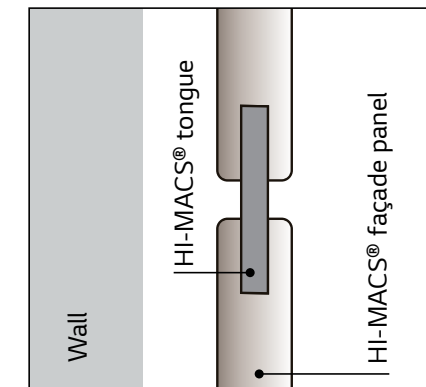

Tongue and groove joints  
(tongue element made from HI-MACS®)



Please feel free to contact us  
for further information.

**HI-MACS®. Because Quality Wins.**

European Headquarters:  
LG Hausys Europe GmbH  
Lyoner Str. 15  
60528 Frankfurt  
Germany  
[info@himacs.eu](mailto:info@himacs.eu)

To find the contact for your region,  
please visit our website.

[himacs.eu](https://www.himacs.eu)



HI-MACS® and Natural Acrylic Stone™ are registered trademarks of LG Hausys Europe GmbH. All other trademarks and product names are trademarks or registered trademarks of their respective rights owners. The information contained in this brochure is intended to be for information only and can be amended at any time without prior notification. ©2019. LG Hausys Europe GmbH. All rights reserved.